

Door configuration		Frame size, mm			
	Width		Height		
	up to 200 kg/sash	over 200 kg/sash			
	1134*-5028*	1752*-6000	1303-2700		
	Sash size, mm				
	Width		Height		
	up to 200 kg	over 200 kg	sash	handle height from the bottom of the sash	
538-2485	847-3335	1185-1778	400		
		1785-2580	1000		
	Width		Height		
	up to 200 kg/sash	over 200 kg/sash			
	1678*-6000	2605*-6000	1303-2700		
	Sash size, mm				
	Width		Height		
	up to 200 kg	over 200 kg	sash	handle height from the bottom of the sash	
538-2485	847-3335	1185-1778	400		
		1785-2580	1000		
	Width		Height		
	up to 200 kg/sash	over 200 kg/sash			
	2150*-6000	3386*-6000	1303-2700		
	Sash size, mm				
	Width		Height		
	up to 200 kg	over 200 kg	sash	handle height from the bottom of the sash	
538-2485	847-3335	1185-1778	400		
		1785-2580	1000		

Max. sash weight 400 kg, Max. sash height / width ratio must be  $\leq 2.5$

\* - symmetrical split

H92

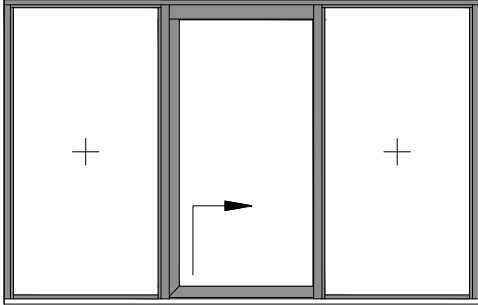
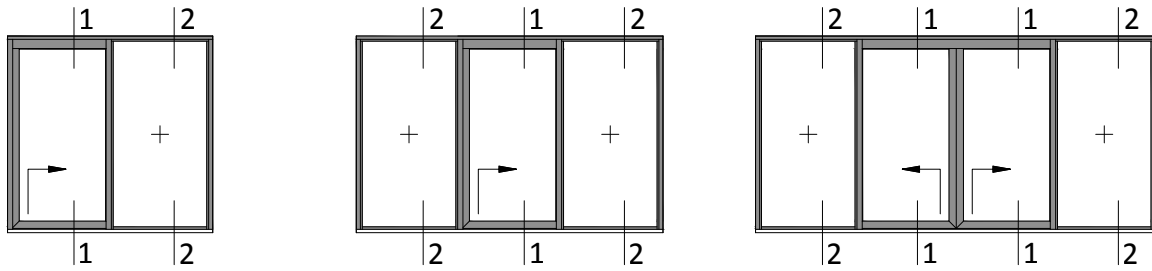

H92-1

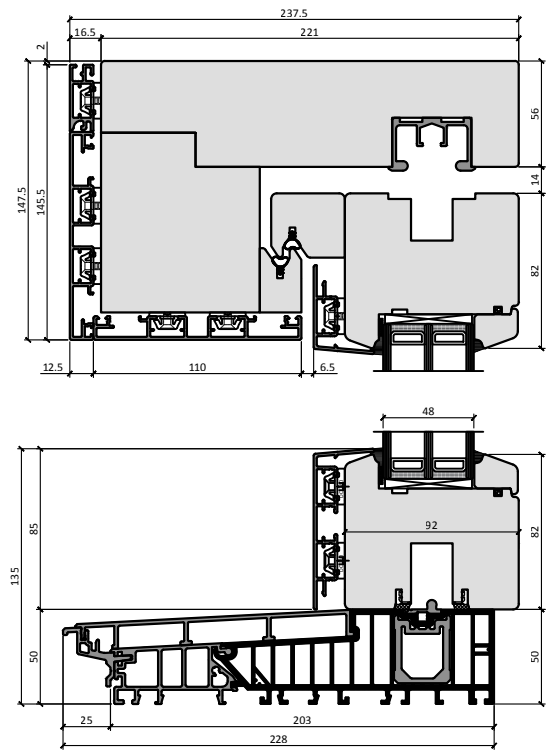

H92-2

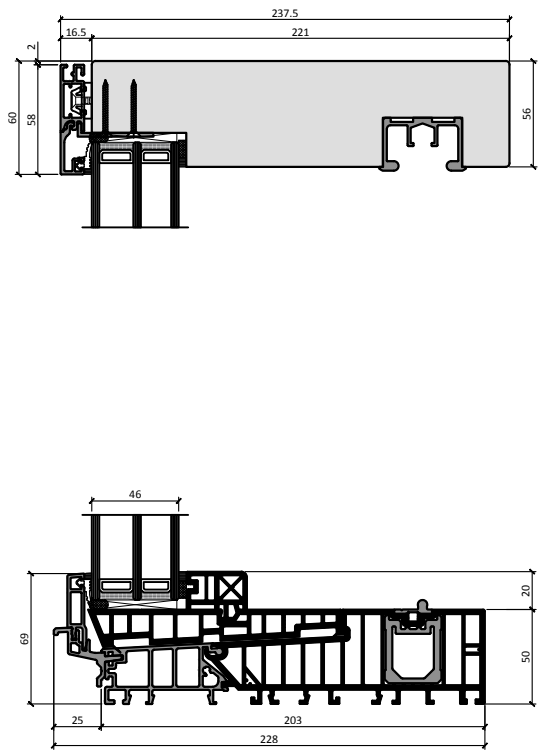

**IMPORTANT NOTE!**



DRAINAGE SLOTS.  
DO NOT COVER !

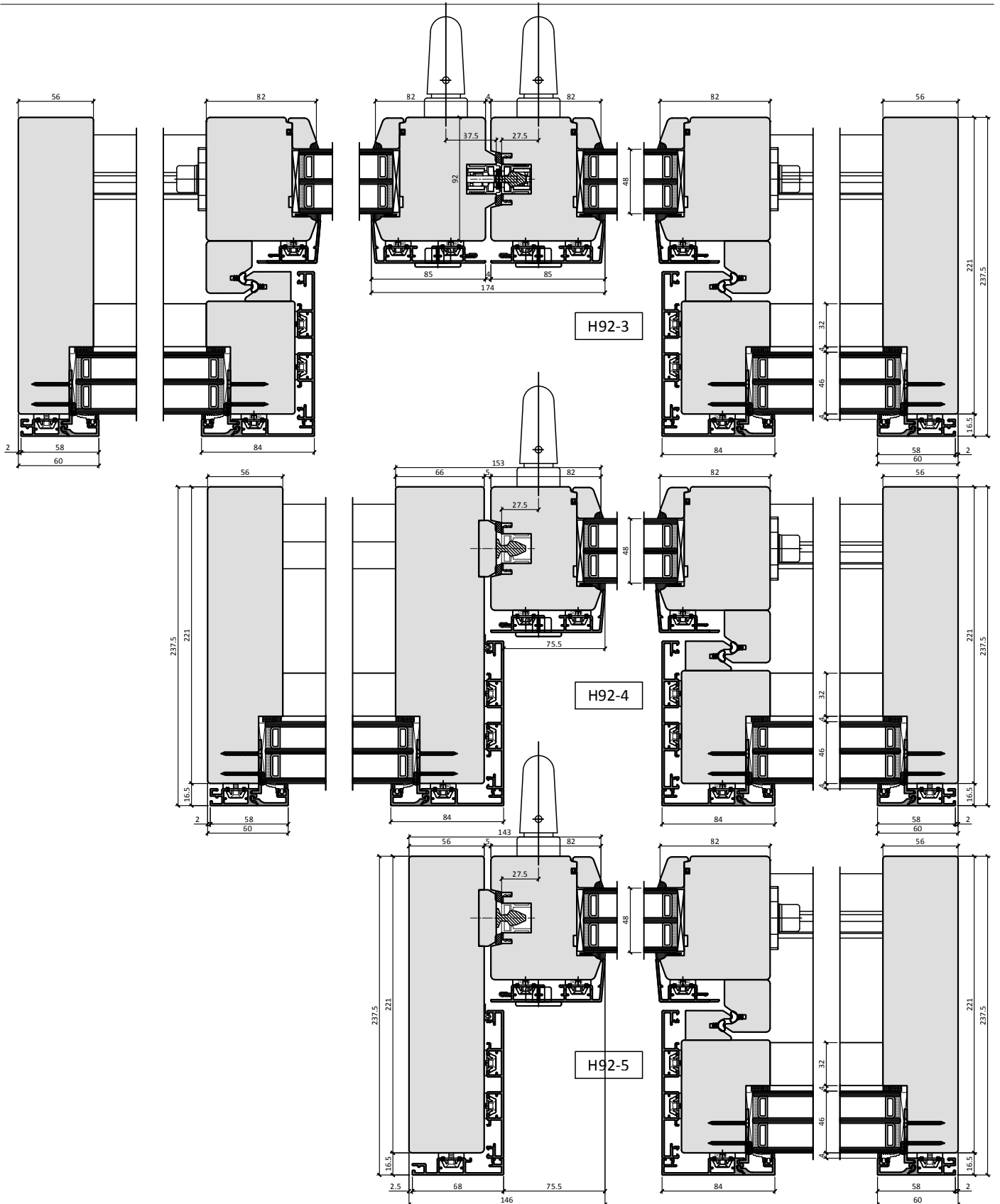
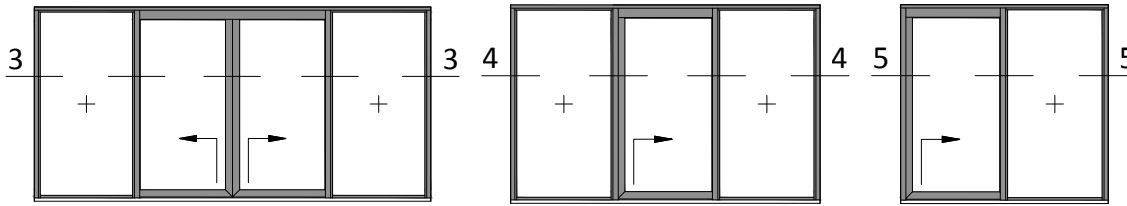

Scale 1:4

H92

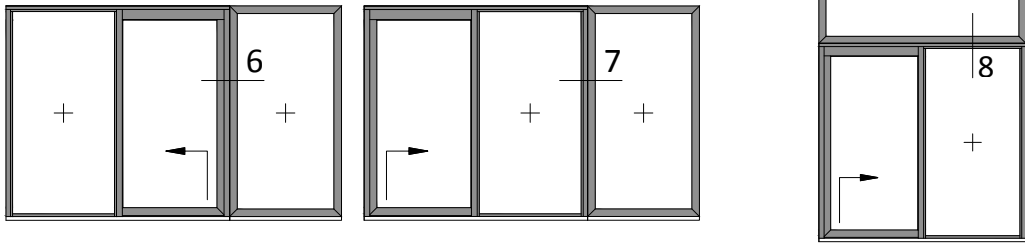

LIFT & SLIDE DOOR COUPLING WITH 92 EUROPA FIXED WINDOW

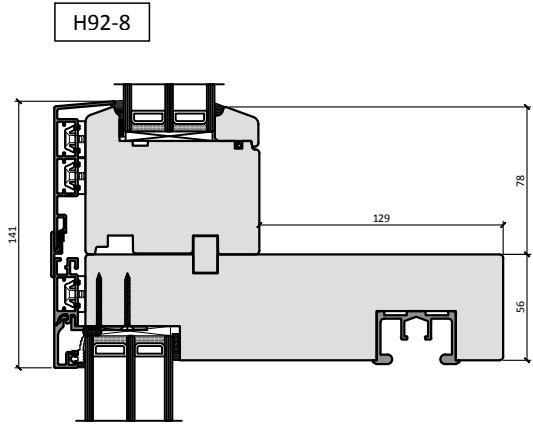
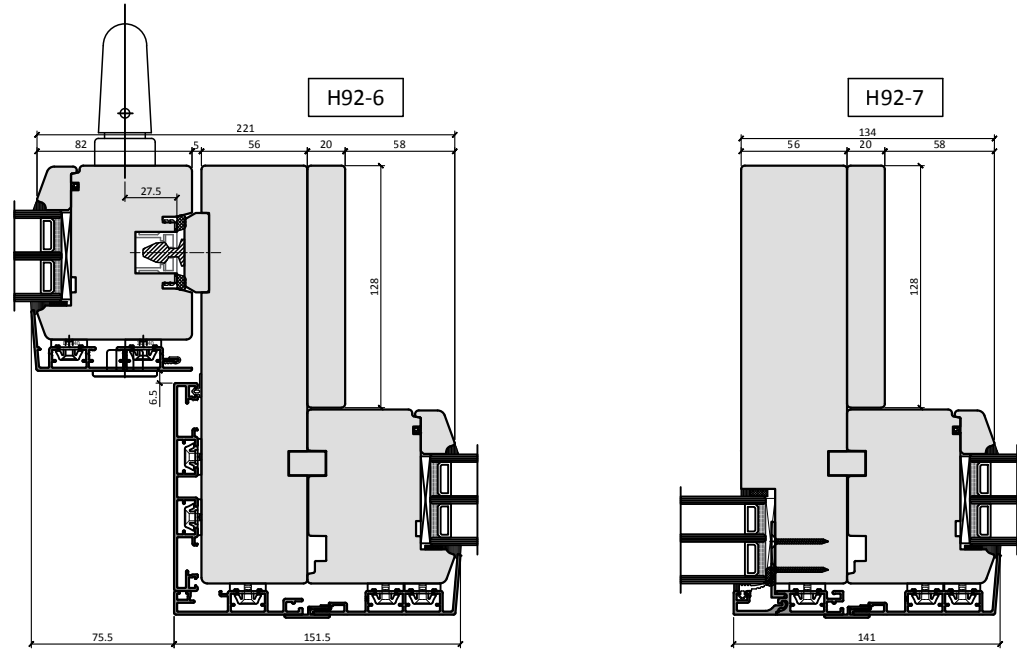

*fixed window glass unit(s) is supplied not sealed with silicone and temporary fixed with glazing bead for easier frame fixing on site*

H92

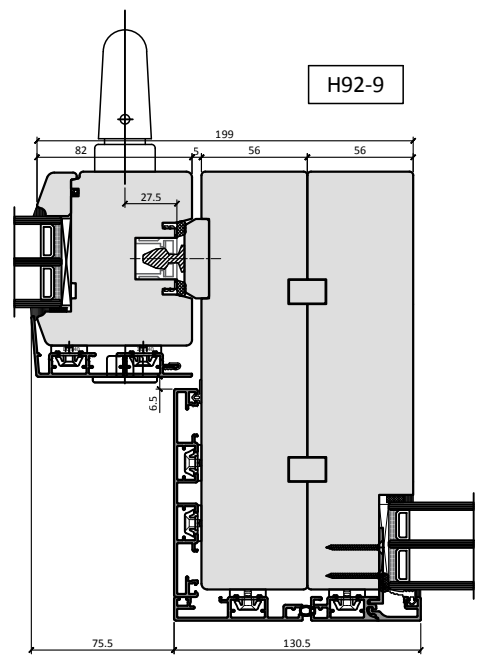
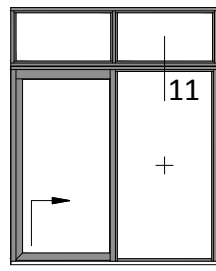
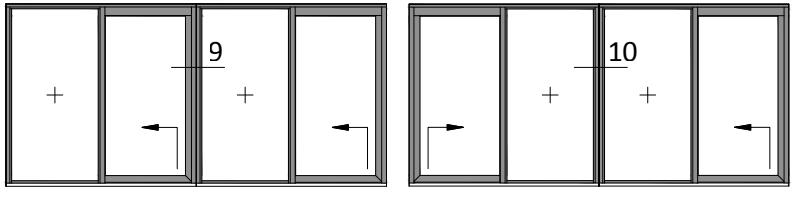

H92-9

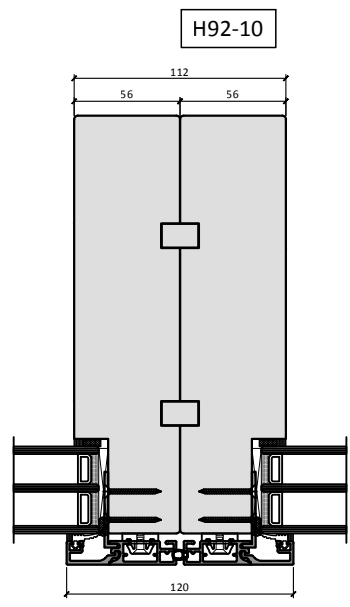

H92-10

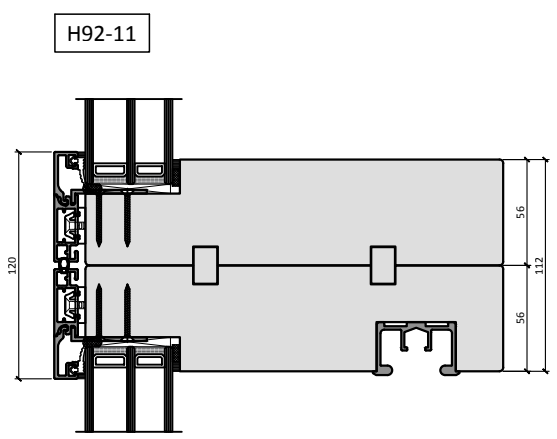

H92-11

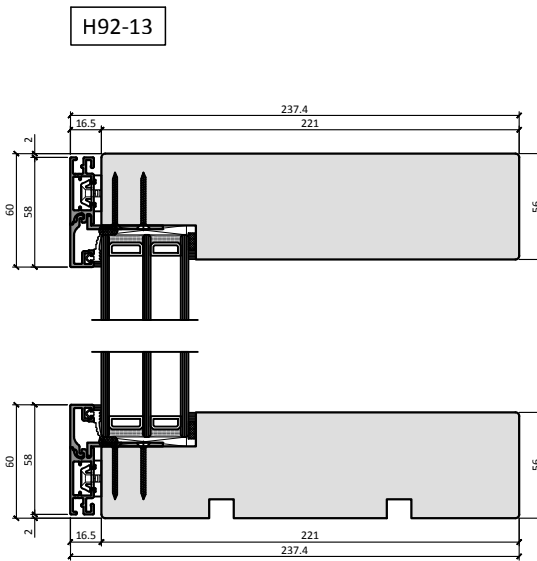
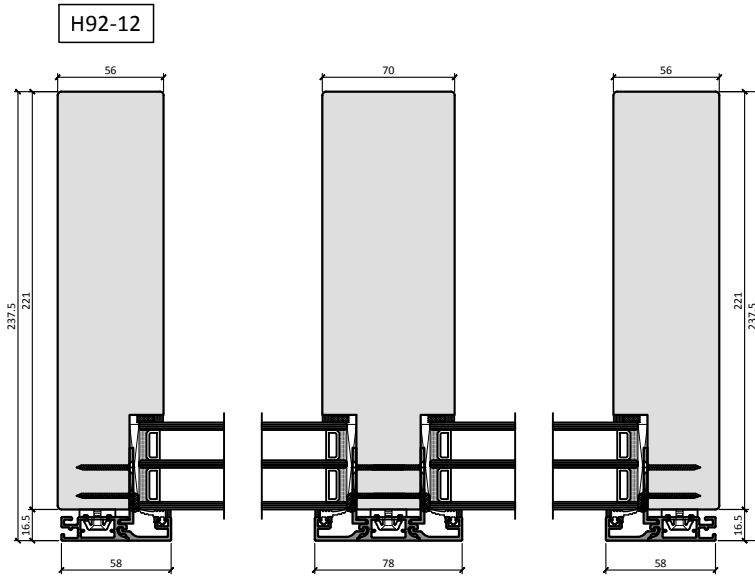
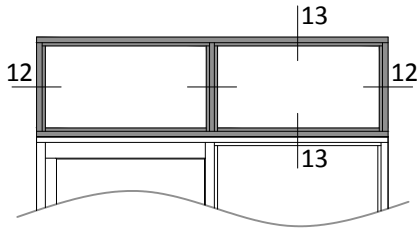

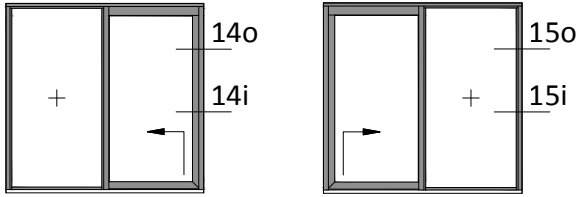

LIFT & SLIDE DOOR COUPLING WITH 92 EUROPA FIXED WINDOW

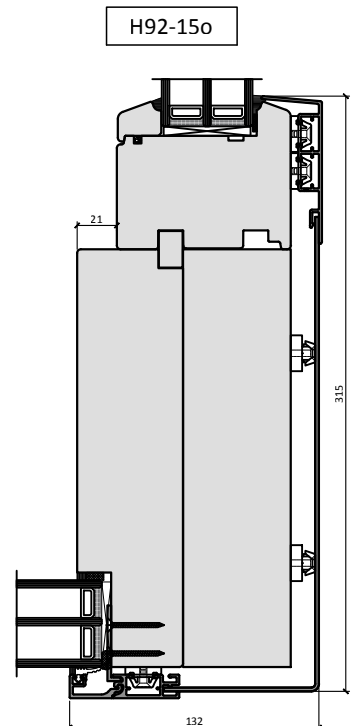
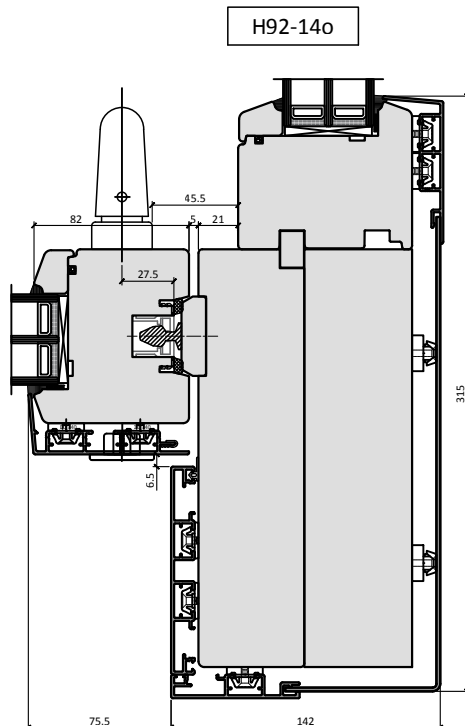
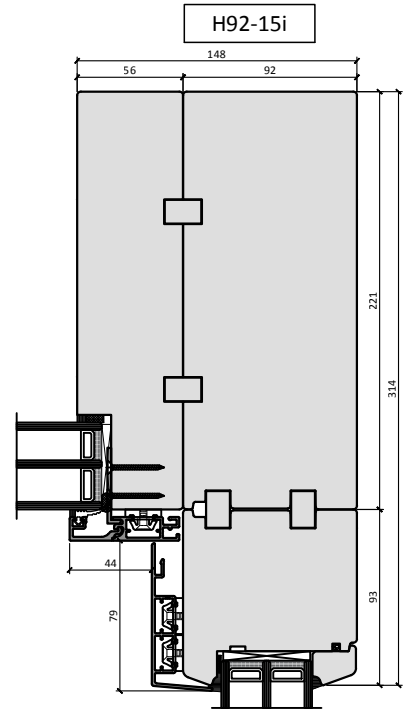
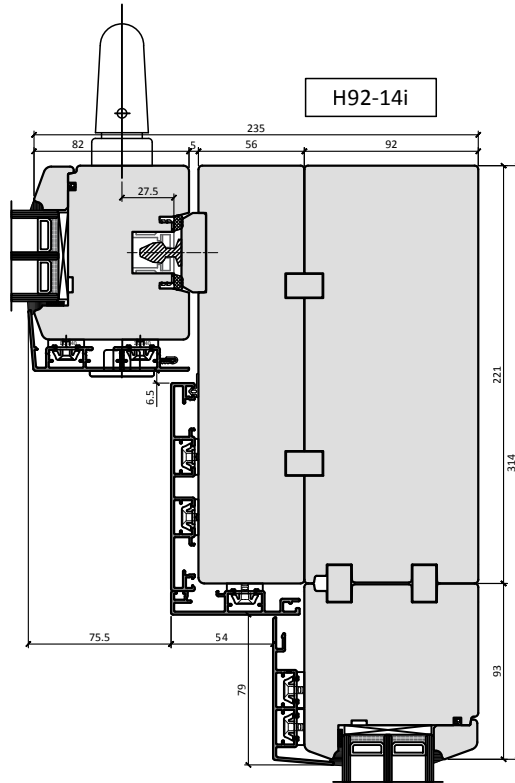

*fixed window glass unit(s) is supplied not sealed with silicone and temporary fixed with glazing bead for easier frame fixing on site*

Scale 1:4

